

SELL-MAR ENTERPRISE, Inc.

Architectural Metal, Glass, Storefront, Acrylic and Door Hardware Supplier

Phone: (718) 299-8484 Fax: (718) 299-5466

www.Sell-Mar.com & Estimating@Sell-Mar.com

SPECIAL DOORS SERIES BI-FOLDING SWING GLASS WALL SYSTEM (Maximum 3 doors per jamb)

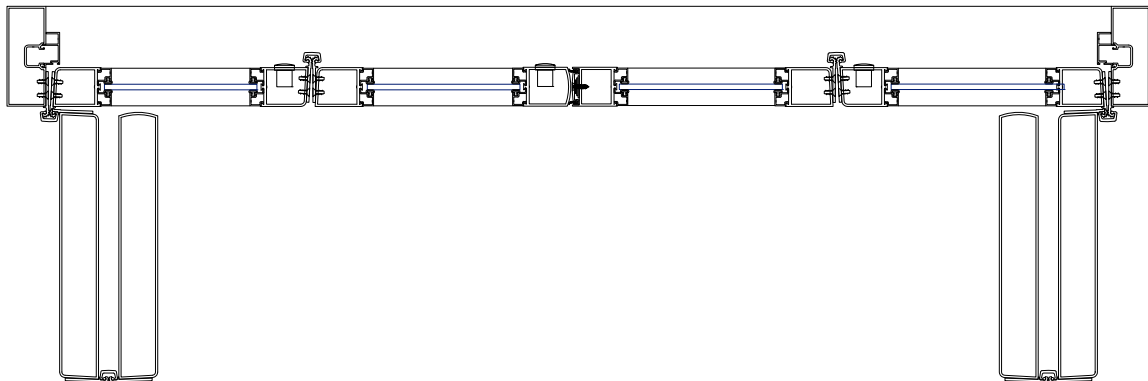
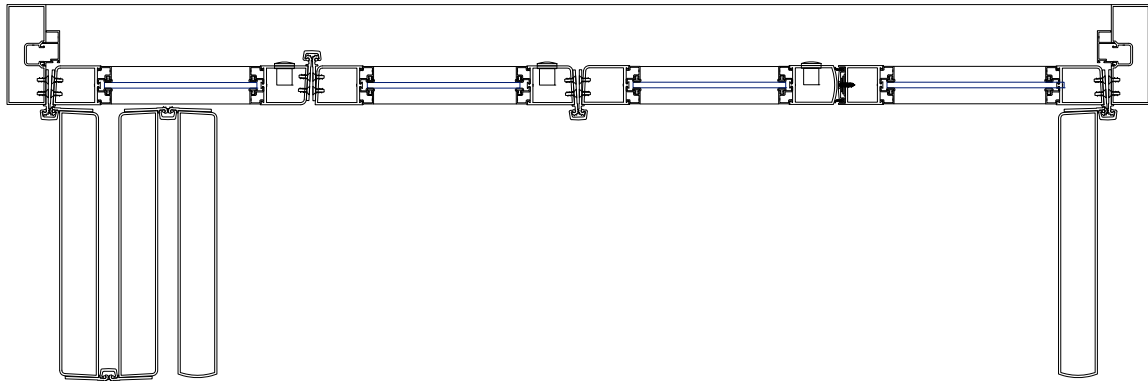
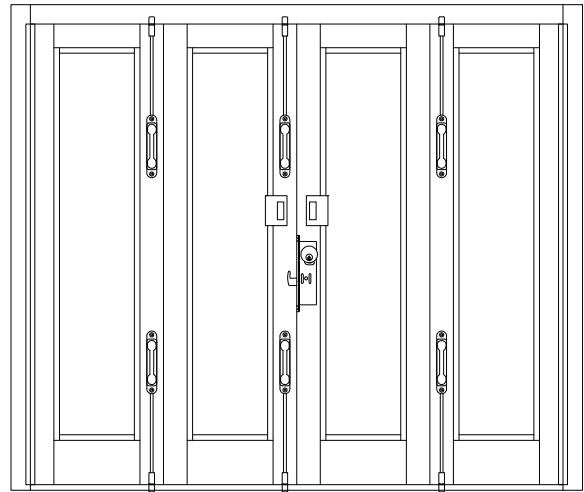
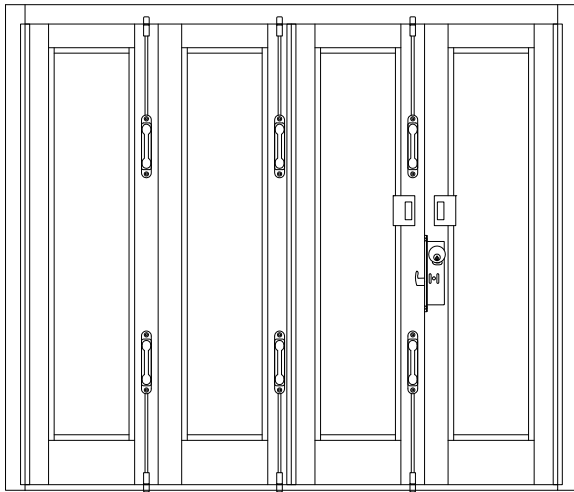

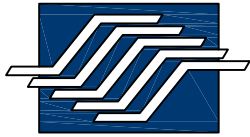

SELL-MAR ENTERPRISE, Inc.

Architectural Metal, Glass, Storefront, Acrylic and Door Hardware Supplier

Phone: (718) 299-8484 Fax: (718) 299-5466

www.Sell-Mar.com & Estimating@Sell-Mar.com

SPECIAL DOORS SERIES BI-FOLDING SLIDING GLASS WALL SYSTEM (Maximum door width 35" - Maximum door height 108" - Maximum door weight 150 lb)

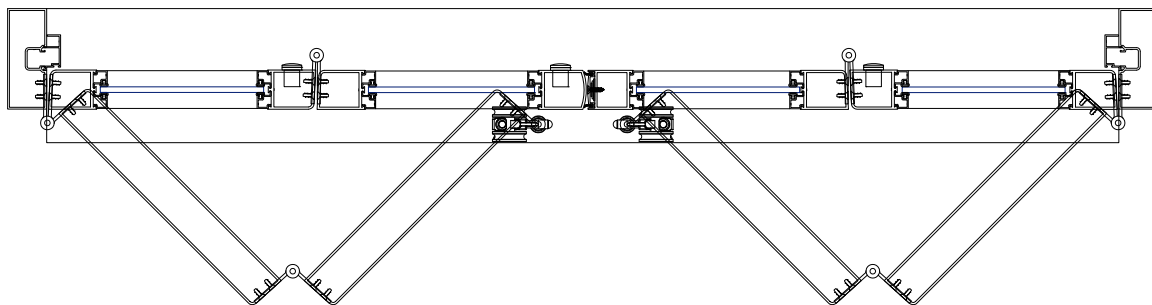
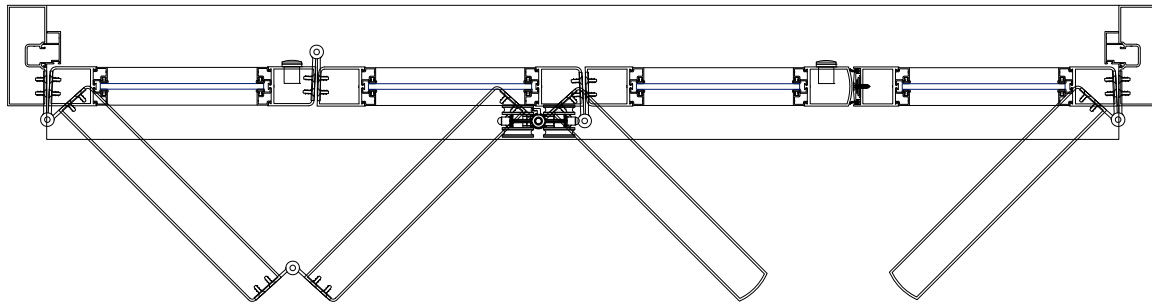
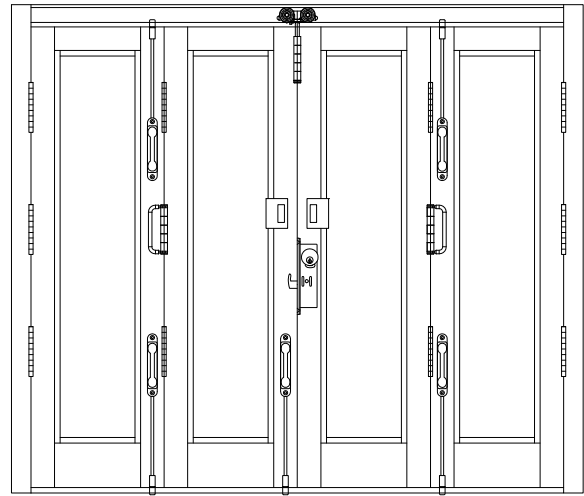
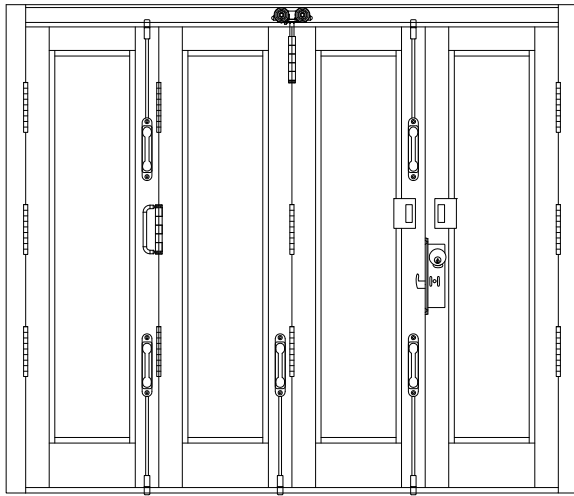



SELL-MAR ENTERPRISE, Inc.

Architectural Metal, Glass, Storefront, Acrylic and Door Hardware Supplier

Phone: (718) 299-8484 Fax: (718) 299-5466

www.Sell-Mar.com & Estimating@Sell-Mar.com

SPECIAL DOORS SERIES
S3000 SLIDING DOORS INTERIOR APPLICATIONS ONLY
AVAILABLE IN NARROW, MEDIUM & WIDE STILE
With Adjustable Tandem Rollers

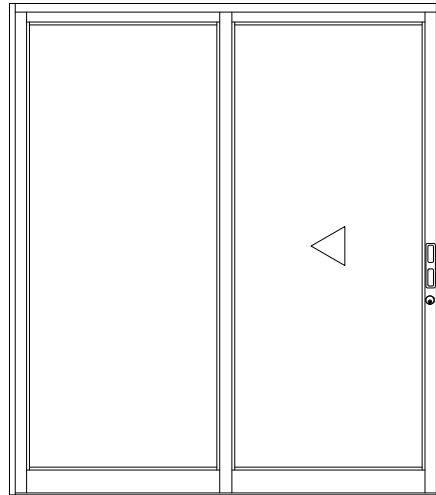

O X

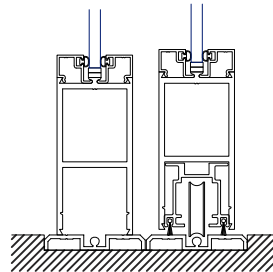
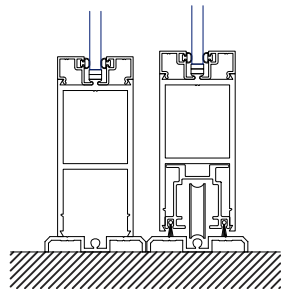
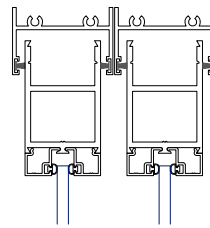
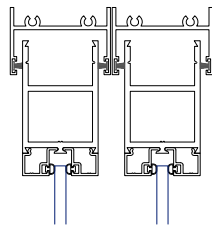

Surface Mounted Tracks

Recessed Tracks

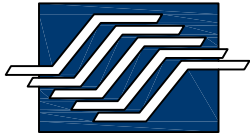

SELL-MAR ENTERPRISE, Inc.

Architectural Metal, Glass, Storefront, Acrylic and Door Hardware Supplier

Phone: (718) 299-8484 Fax: (718) 299-5466

www.Sell-Mar.com & Estimating@Sell-Mar.com

SPECIAL DOORS SERIES STAINLESS STEEL OR BRASS CLAD DOOR AND FRAME

