















SELL-MAR ENTERPRISE, Inc.

Architectural Metal, Glass, Storefront, Acrylic and Door Hardware Supplier

Phone: (718) 299-8484 Fax: (718) 299-5466

www.Sell-Mar.com & Estimating@Sell-Mar.com

STOCK LENGTHS 24' UNLESS NOTED OTHERWISE

| CW2500 2½" CURTAIN WALL SYSTEM | | | |
|--------------------------------|--------------|---|---|
| 1 | 1101 |  | 2½" X 5½" BACK MEMBER |
| 2 | 1102 |  | 2½" X 3½" BACK MEMBER |
| 3 | 1103 |  | 2½" X 2¾" BACK MEMBER |
| 4 | 1104 |  | ¼" REDUCER |
| 5 | 1106 |  | TERMINATOR |
| 6 | 1107 |  | ½" X 2½" VERTICAL SNAP COVER |
| 7 | 1108 |  | ½" X 2½" HORIZONTAL SNAP COVER |
| 8 | 1105 |  | PRESSURE BAR (MILL) |
| 9 | 1109 |  | CURTAIN WALL CLIP (MILL) 6' |
| 10 | 3580 |  | CURTAIN WALL INSULATED GASKET (500') |
| 11 | 3581 |  | CURTAIN WALL GASKET (500') |
| 12 | HEXHEADSCREW |  | Curtain wall hex washer screw (100 pcs) |

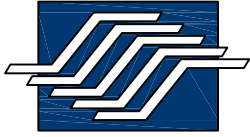

SELL-MAR ENTERPRISE, Inc.

Architectural Metal, Glass, Storefront, Acrylic and Door Hardware Supplier

Phone: (718) 299-8484 Fax: (718) 299-5466

www.Sell-Mar.com & Estimating@Sell-Mar.com

CURTAIN WALL PICTORIAL VIEW

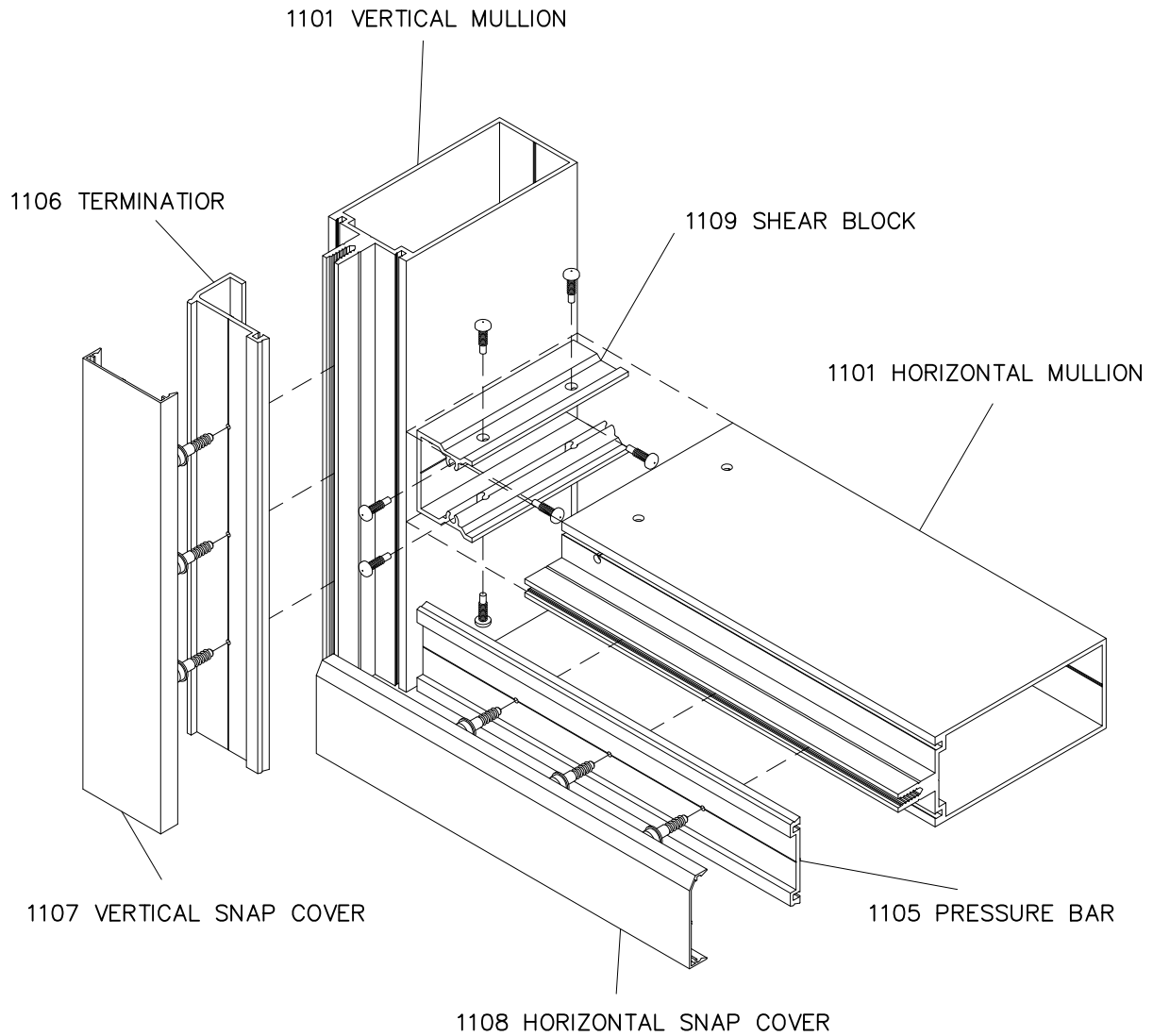

IT MAY BE NECESSARY TO ATTACH HORIZONTAL TO SHEAR BLOCK THROUGH TOP OR BOTTOM TO KEEP TIGHT JOINT AT REAR.